

## Maxxus Infrared Sauna Instruction Manual

**Models MX-K106-01 / MX-K206-01 / MX-K306-01 / MX-K406-01**



FOR CARBON MODEL SAUNAS

HEMLOCK AND RED CEDAR MODELS

FOR INDOOR USE ONLY

120V/15AMP DEDICATED CIRCUIT REQUIRED FOR MX-K106-01 & MX-K206-01

120V/20AMP DEDICATED CIRCUIT REQUIRED FOR MX-K306-01 & MX-K406-01

# Thank you for choosing Maxxus Infrared Sauna!

## Index

=====

|                               | Page |
|-------------------------------|------|
| Important Safety Guides.....  | 2    |
| Introduction.....             | 3    |
| Health & Beauty Benefits..... | 3    |
| Highlights.....               | 4    |
| Assembly.....                 | 4    |
| Sauna Operation.....          | 11   |
| Warnings.....                 | 13   |
| Troubleshooting.....          | 13   |
| Maintenance.....              | 15   |
| Transportation.....           | 15   |
| Packing List.....             | 15   |
| Warranty.....                 | 16   |
| Warranty Card.....            | 18   |

**WARNING:** Visually inspect all heaters before assembly to make sure they are not damaged. Any excessive vibrations during transport could cause damage to the heating elements. **DO NOT START** the sauna if damage is detected! Contact your dealer or manufacturer for troubleshooting and replacement parts.

### DISCLAIMER

The infrared rays emitted by your sauna are reported to offer a wide range of possible therapeutic benefits based on research completed over the last 25 years from all around the world. These benefits are presented for reference purposes only and no implication of infrared saunas creating a cure for or treating any disease is implied nor should it be inferred. If you have a health condition, are taking prescription drugs, or have acute joint injuries, please consult your medical physician before starting infrared therapy. Persons with surgical implants (metal pins and rods, artificial joints, silicone, or other types of surgical implants) typically do not experience any adverse effects, but should also consult their physician or surgeon before starting infrared therapy. Models are subject to change without notice. Pictures shown are for representation purposes only and may not resemble your exact model.

# **READ IMPORTANT SAFETY GUIDES BEFORE USING!**

## **READ AND FOLLOW ALL INSTRUCTIONS**

- A). Please following all warning labels and markings on the sauna room.**
- B). Do not install any receptacles on the interior or exterior walls of the sauna room.**
- C). No locking devices are installed or shall be installed on the door of the sauna room which could result in entrapment within the sauna room.**
- D). During use, the ceiling vent can be in the opened position.**
- E). CAUTION! Hyperthermia Danger: the normal body temperature can't rise above 103°F. Symptoms of excessive hyperthermia include dizziness, lethargy, drowsiness, and fainting. The effects of excessive hyperthermia may include failure to perceive heat, physical inability to exit sauna, unawareness of impending hazard, unconsciousness and fetal damage in pregnant women. Hyperthermia could make your body's core temperature rise. Setting desired temperature to an excessively high temperature is not recommended.**
- F). Do not use drugs, medications, or consume alcohol prior to or during the sauna session as they may lead to unconsciousness and/or other harmful physical injuries. If absolutely necessary, persons using medications should consult a physician before using the sauna. Some medications may induce drowsiness while others may affect the heart rate, blood pressure, and/or blood circulation.**
- G). WARNING! Your hands must be dry and free of moisture before plugging and unplugging cords and wiring harnesses from the power supply and circuit boards. Never operate the sauna with wet hands or wet feet to avoid risk of electric shock. Never touch the metal prongs of the plug.**
- H). Persons suffering from obesity or with a medical history of heart disease, low or high blood pressure, circulatory system problems, or diabetes should consult a physician prior to using the sauna.**
- I). Do not pour water or any other liquids on the infrared emitters. Do not place combustible materials near on or on the heaters. Do not bump, hit, or break the heating elements as it may cause an electrical short and pose a safety risk.**
- J). To reduce the risk of injury, do not allow children to use the sauna unless they are closely supervised by an adult and use of the sauna has been prescribed by a medical physician.**
- K). If the power supply cord becomes damaged, it must be replaced immediately by the manufacturer or its agent. If you find the power cord is too hot or that the electrical equipment may be experiencing technical problems, please contact the manufacturer or its agent immediately to avoid hazardous conditions.**
- L). Pregnant or possibly pregnant women should contact their physician prior to using the sauna. Excessive temperature has a high potential for causing fetal damage during pregnancy.**

- M). Never sleep inside the sauna.
- N). Do not use any type of cleaning agents on the interior of the sauna. Only wipe down with a cloth and water.
- O). Do not stack or store any object on top or inside the sauna.
- P). Do not use the sauna during an electrical storm to avoid risk of shock.
- Q). Do not attempt to make any repairs yourself. If a problem occurs with the sauna, please contact seller, distributor, or the manufacturer to avoid safety risks. Unauthorized repair attempts will void the manufacturer's warranty.
- R). Please make sure the outlet power supply meets the specifications required. Failure to meet the requirements may cause safety risks.
- S). Some sauna models are equipped with reading and roof lamps. Because the lamp temperature will become very hot once powered on, do not attempt to touch the lamp to avoid being burned. Do not attempt to touch it for at least 20 minutes after it has been powered off.
- T). Do not make any modifications to the sauna, the sauna structure, or the sauna components.

## SAVE THESE INSTRUCTIONS

### Introduction

We welcome you to the most affordable infrared sauna in the nation! We also congratulate you on your new path to better health! Thousands of users enjoy the benefits of infrared saunas every day. Infrared saunas help you burn calories, reduce toxins, relieve pain and even clear complexions. Now you can enjoy the great benefits of far infrared heat within the privacy of your own home.

### Health & Beauty Benefits

**Relieve pain:** The far infrared rays of a sauna accelerate the blood circulation and supply more oxygen to the body. Increased blood circulation diminishes inflammation, relieves pain, and speeds up recovery. Infrared saunas have also been used to treat bursitis, rheumatism, arthritis, and hemorrhoids. Increased blood circulation not only alleviates internal ailments, but also skin conditions such as psoriasis, eczema and scars. Good circulation is essential for smooth and healthy skin.

**Burn calories & fat:** The far infrared rays of the sauna eliminate extra salt and subcutaneous fat. Burn up to 600 calories in a half hour session versus a half hour of jogging which burns 300 calories or a half hour of cycling- which burns 225 calories.

**Relax your body and mind:** Use the built-in CD player to listen to your favorite music to relax and reduce stress. Infrared saunas also improve symptoms of insomnia and other stress related disorders.

**Reduce toxins and improve complexions:** Perspiring in a lower temperature environment activates the sweat glands and expels toxins and heavy metals from the body.

## Highlights

- a. High quality craftsmanship
- b. Automatic thermostat for constant temperature
- c. Timer and buzzer: buzzer sounds 5 minutes before the end of the sauna session
- d. Digital sensor and thermometer
- e. Infrared carbon heat emitter panels
- f. Wiring diagram:

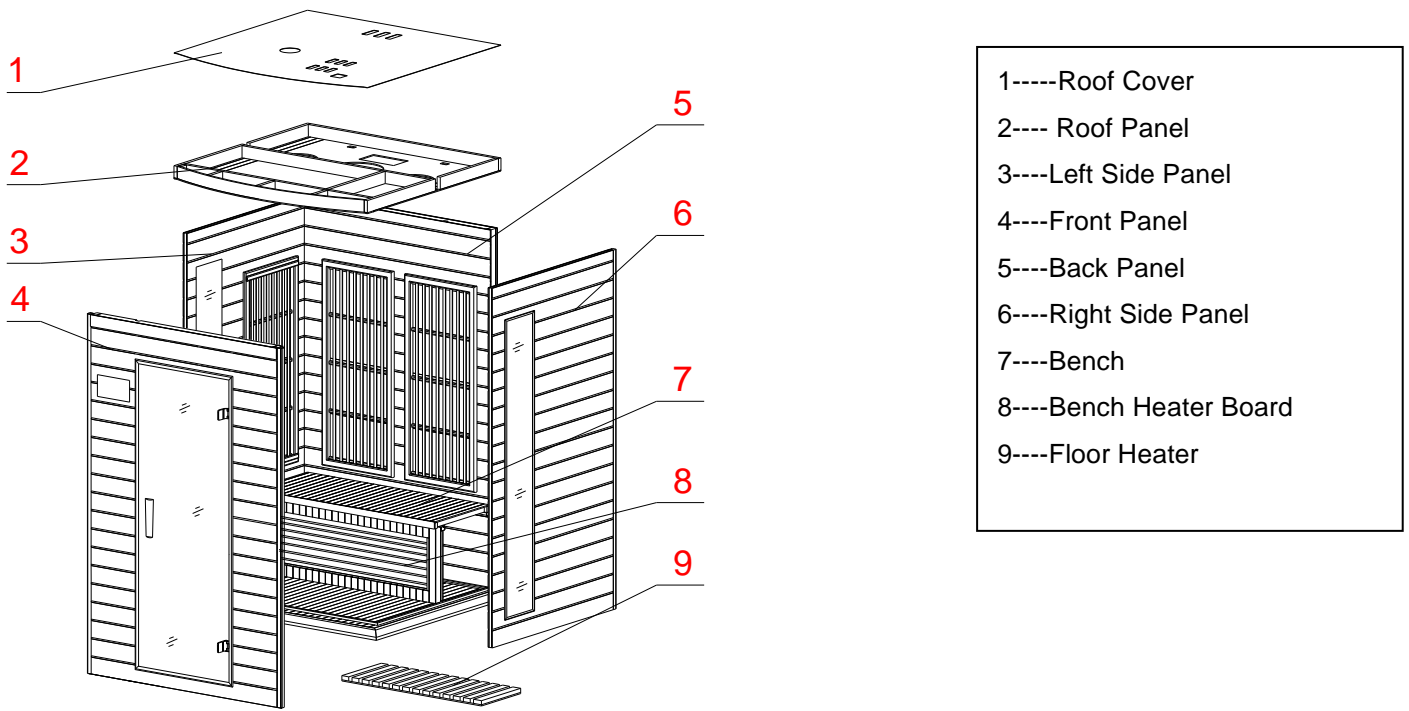
## Assembly

### Assembly Requirements

- a. You will need a philips screwdriver, ladder, and two adults to assemble.
- b. Do not plug any other appliances into the power supply of the sauna room other than the designated sauna connections/plugs.
- c. Assemble the sauna room on a completely level surface.
- d. Do not spray or get water on the exterior/interior walls of the sauna room. If the floor is damp, install a floor separator to keep the sauna high & dry.
- e. Do not store flammable objects or chemical substances near the sauna.

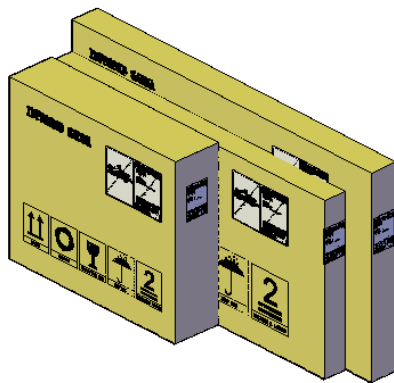
### **Sauna Room Assembly:**

1. Structure of Infrared Sauna. **See FIG-1**
2. Make sure all parts are present before installing the unit. See packing list below.
  - A.** Front Panel      **B.** Floor Panel      **C.** Back Panel      **D.** Left Side Panel      **E.** Right Side Panel
  - F.** Bench              **G.** Bench Heater Panel      **H.** Roof Panel      **I.** Roof Cover      **J.** CD Player
  - K.** CD Player Box      **L.** Floor Heater      **M.** Handle

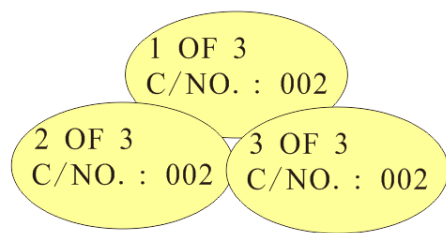


**FIG-1**

3. 1-person sauna models are packed in one carton and 2-person sauna models are packed into two cartons. For example: C/NO: 002 1 OF 2 and C/NO: 002 2 OF 2. 3-person sauna and 4-person saunas are packed in three cartons. For example: C/NO: 002 1 OF 3, C/NO: 002 2 OF 3, and C/NO: 002 3 OF 3. See **FIG-2.1 & 2.2**

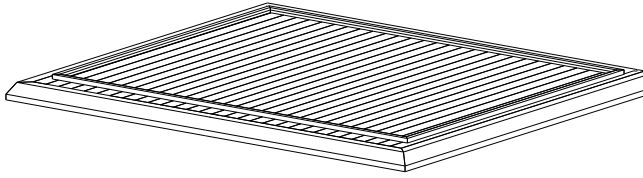


**FIG-2.1** Cartons

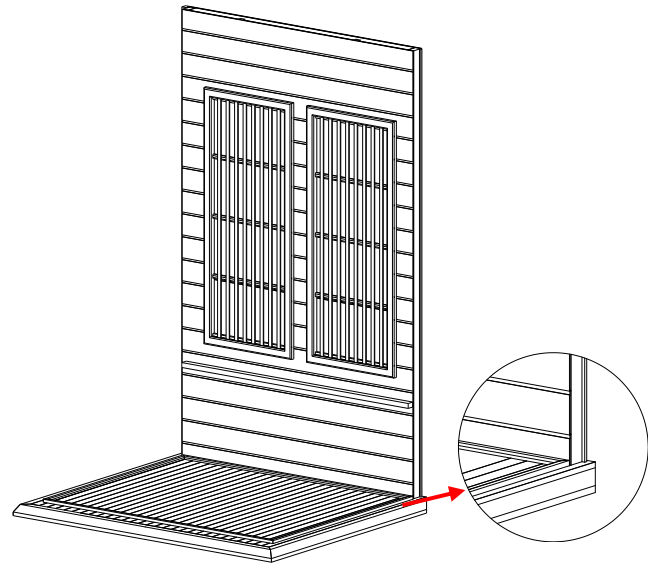


**FIG-2.2** C/No.

4. Place the Floor Panel on a smooth/flat surface and make sure which side is the front and which side is the back. See **FIG 3**.



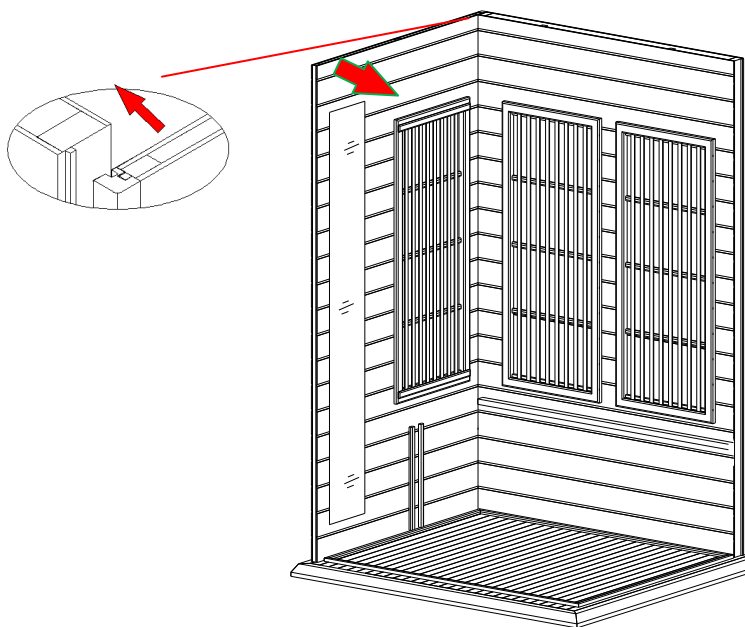
**FIG 3** Placing Floor Panel



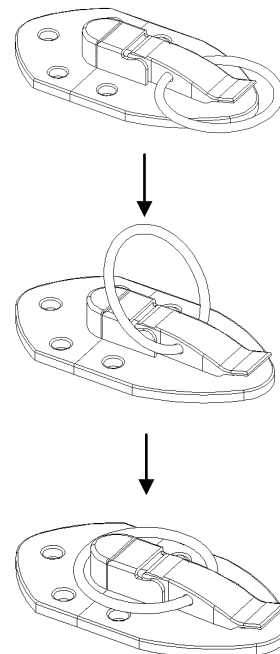
**FIG 4** Assembling Back Panel

- Align the Back Panel with the Floor Panel's corresponding wood pattern; make sure the wood pattern is flowing in the same direction. One person should hold the Back Panel while the other person continues to the next step. **See FIG 4**

- Align the Left Side Panel with the Floor Panel's corresponding wood pattern; make sure the Left Side Panel fits flush into the Back Panel. **See FIG 5**



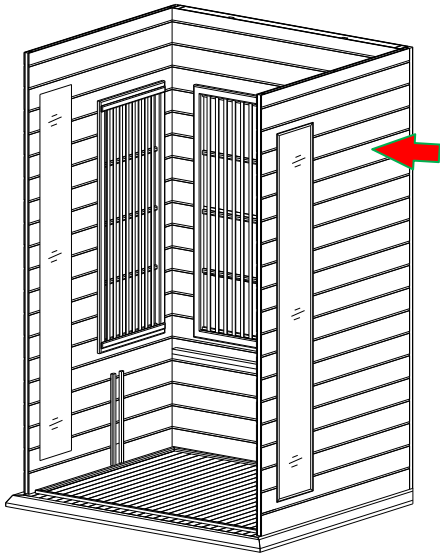
**FIG 5** Assembling Left Side Panel



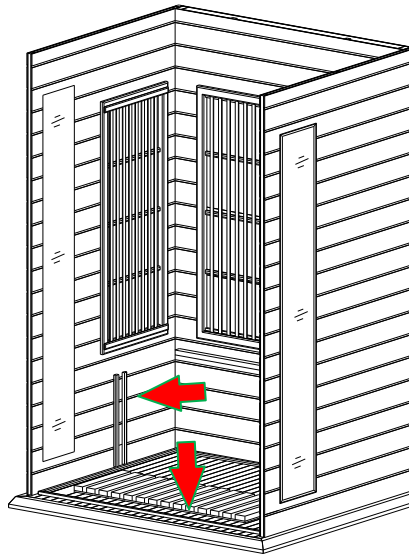
**FIG 6** Buckle

- For model MX-K106-01, you will use the provided screws to screw the wall panels together. For all other models, latch the Left Side Panel with the Back Panel. The buckle has a guide tab that must be placed in the guide slot for alignment. When the Back Panel and the Side Panel is attached together on the floor panel, make sure all the buckles are latched. **See Figure 6**

8. Align the Right Side Panel with the Floor Panel's corresponding patterns; make sure the Right Panel fits flush into the Back Panel and latch together. Again, for model MX-K106-01, you will use the provided screws to screw the wall panels together. **See FIG 6 and FIG 7**

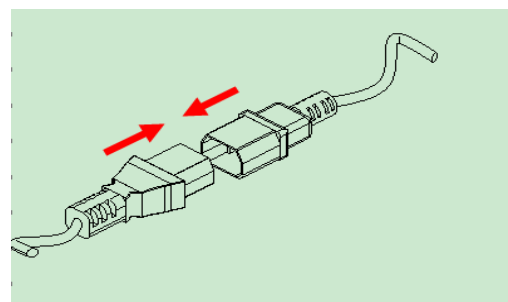
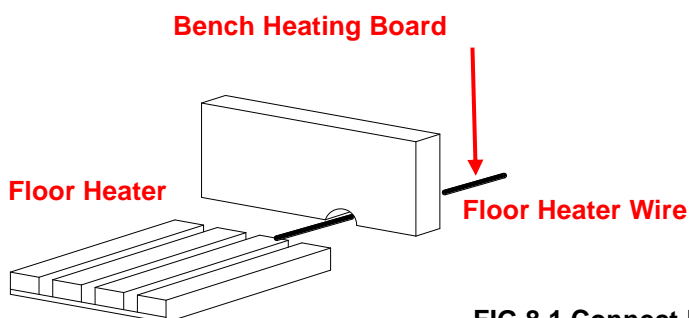


**FIG 7** Assembling Right Panel



**FIG 8** Placing Floor Heater

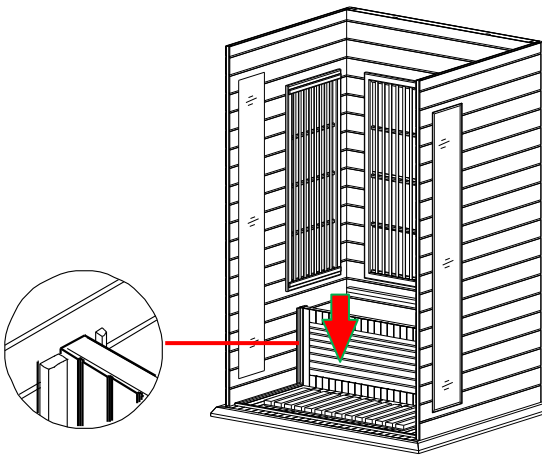
9. Place the Floor Heater on the Floor Panel making sure that the Floor Heater is in front of the Bench Heater Panel slots. Please note there is a pre-cut small hole under the Bench Heater Panel which is provided for the Floor Heater cord. This cord will connect the Floor Heater to the plug outlet on the Left Side Panel. **See FIG 8 & 8.1**



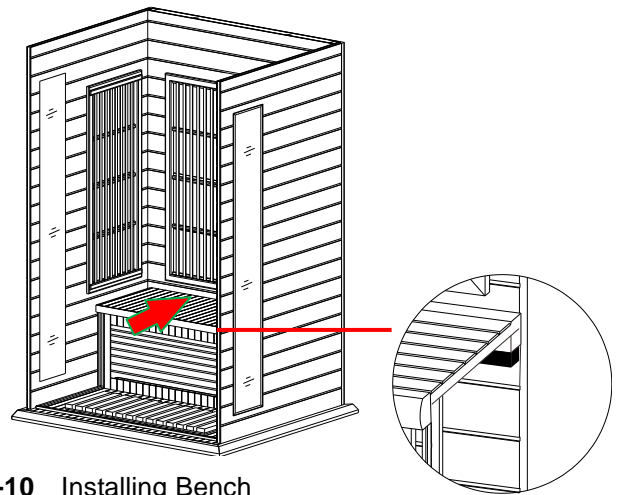
**FIG 8.1** Connect Floor Heater

10. Slide the Bench Heater Panel down (vertically) into the slot provided on both the Left and Right Side panels. Connect the Bench Heater Panel cord with the outlet on the Back Panel and then place the Bench on top of the Bench Heater Panel and slide it into place. **See FIG 9 & 10** Note: Make sure the cords are connected snug and tight, otherwise the heater will not work.



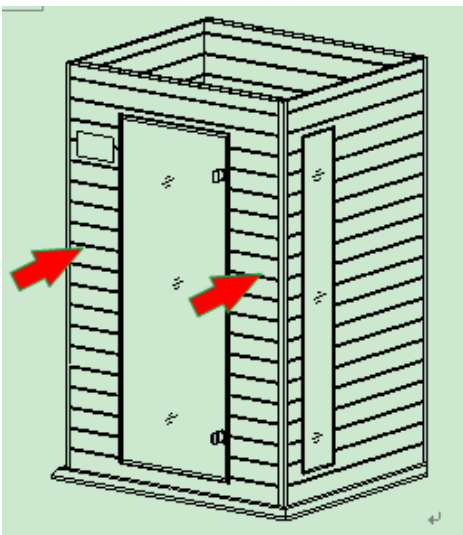


**FIG 9** Connecting Cord

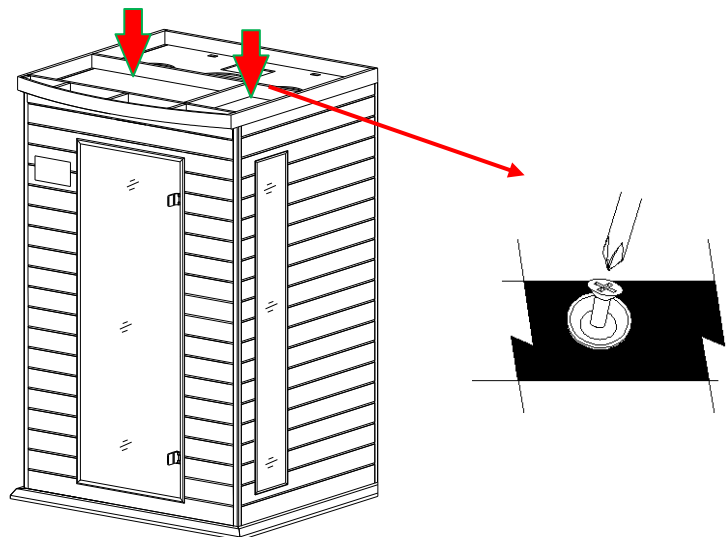


**FIG-10** Installing Bench

11. Align the Front Panel with the Floor Panel's corresponding patterns; make sure the wood pattern is flowing in the same direction. Next, latch the Front Panel with the Left and Right Side Panels respectively. Note: Be cautious with the glass door to avoid breakage. **See FIG 11.**

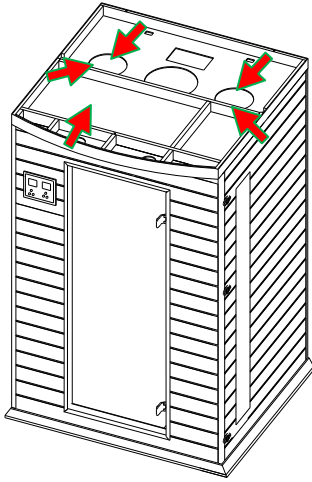


**FIG 11** Assembling Front Panel

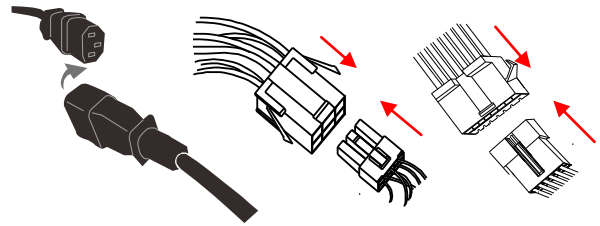


**FIG 12** Installing Roof Cover

12. Place cords/wires of Front Panel and Back Panel into the sauna room area to avoid damaging the cords/wires during the roof installation. Open the door, lift the Roof Panel up and over the sauna room, and gently lower it into place resting it on the wall panels. Make sure that all cords/wires are slipped through the corresponding holes in the Roof Panel. Proceed in screwing the Roof Panel down. **See FIG 12 & 13**



**FIG-13** Slip cords/wires through corresponding holes



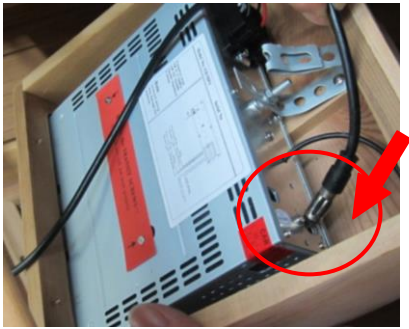
**FIG-14** Connecting cords/wires connectors

13. Connect all the wires and connectors to the corresponding outlets on the Roof Panel. Please be sure all the plugs are connected snug and tight. **See FIG-14.** Next, pull down the cords/wires of the power plugs of the speakers, temperature sensor, control panel and CD player through the hole near the fan on the Roof Panel. **The CD Player (radio) is not available on model MX-K106-01.**

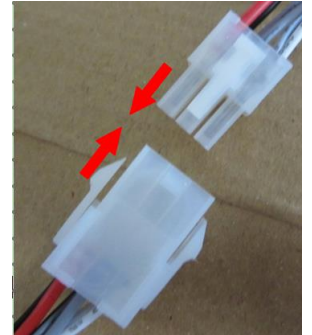
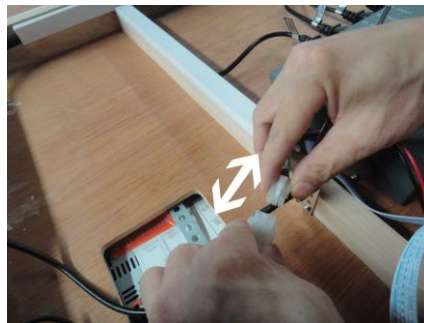
14. The CD Player will already be mounted in its wood housing box. Connect the antenna to the CD player. Next, feed the wires up through the roof. Connect the antenna into the rear of the radio and connect the radio harness up o the roof. **See FIG 15.1** Next, mount the wood housing box to the ceiling of the sauna room. **FIG 15.2 and 15.3.**

**Note:** CD player may not be available on all model sauna rooms

**Step 1**



**Step 2**



**FIG 15.1** Screw CD Player into sauna room

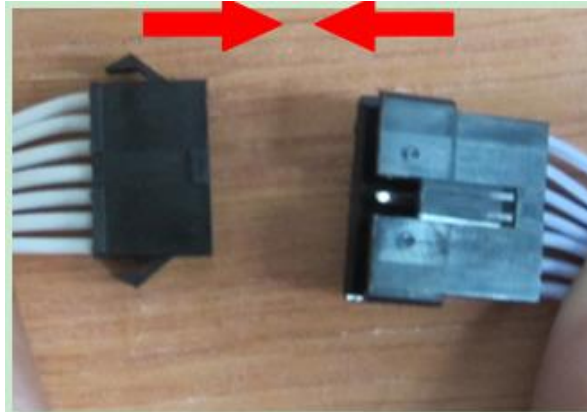


**FIG 15.2** Installing the Radio Wood Housing



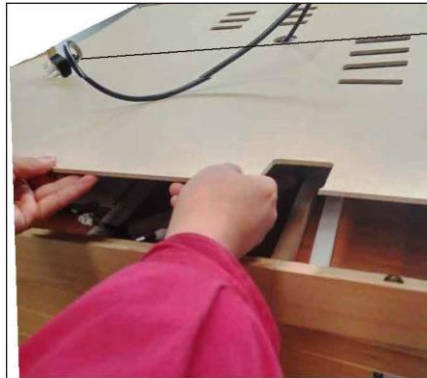
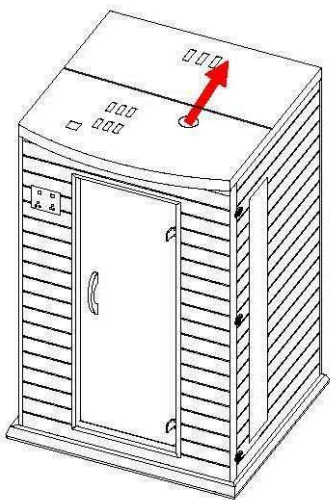
**FIG 15.3** Screwing in the Radio Wood Housing

15. Connect the control panel connectors. **See FIG 16**

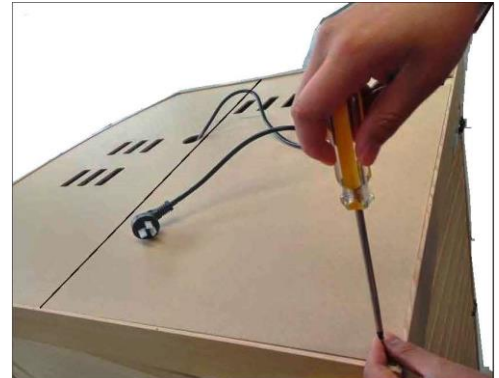


**FIG 16** Connecting control panel connectors

16. Make sure all steps are completed correctly. Plug in the power cord to your wall outlet. Turn on the sauna at the control panel to confirm that the control panel is responding. If the control panel responds accordingly, then proceed in putting the Roof Cover onto the Roof Panel. Make sure to pull the power cord through the corresponding hole in the Roof Cover. **See FIG 17**



**FIG 17** Slip the power cord through Roof Cover



**FIG-18** Screw down the Roof Cover

17. Screw down the Roof Cover to the Roof. **See FIG-18**

18. Attach the door handle and screw into place. Screw cup-holder and magazine rack to the interior wall panel. (Cup-holder and/or magazine rack are not available on all models.)

**Installation Completed.**

## Sauna Operation



### 1. Precautions

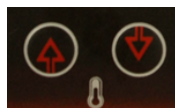
- a. Please make sure your wall outlet meets the specifications required. Failure to meet the requirements may cause safety risks.
- b. Set the temperature and time to a comfortable level. The average used temperature range is between 118°F – 122°F. The average sauna session is approximately 20 – 30 minutes. **You must pre-heat sauna room to the desired temperature before entering.**



**Note:** If the ambient temperature is below 72°F, the sauna will take longer to pre-heat. It is not recommended to use the sauna in an environment with an ambient temperature below 60°F.


- c. Drink water prior to, during, and after your sauna session to replenish body fluids.
- d. After 2 hours of continuous use, the sauna needs to be shut down for one hour.
- e. To avoid burns, do not touch the heating element.


### 2. Operating The Sauna


- a. Review the electrical label on the sauna and then plug the sauna into the proper wall outlet. No other appliance can be operated on the same electrical breaker as the sauna when the sauna is in use. Proceed in turning on the sauna room using the ON/OFF button to activate the sauna.
- b. The sauna should be **unplugged** when not in use. If you do not have access to the plug, it is recommended to use a heavy duty surge protector.







- c. **To set the temperature**, press the  temperature buttons to increase or decrease the temperature to the desired temperature. If the “Heat” light is on, the temperature setting will increase one degree every time the  button is pressed. If pressed for three seconds, the setting will increase quickly.


Decrease the temperature in the same manner by pressing the  button. After the sauna reaches the desired temperature, the “Heat” light will turn off.

d. Press the  button to turn the light ON. If you want to use the **Color Light Therapy System**:


1. While the interior light is ON, press and hold down the  button for 2 seconds. You will notice “2n” in the LED display. This indicates you are in the “light” mode. If you do not press any buttons for approximately 15 seconds, the “2n” will change back to the Timer mode.

2. While the “2n” is displayed, you can now turn the exterior light ON/OFF by pressing the  button in the  section of the control panel.

3. You can also turn the interior light ON/OFF by pressing the  button in the  section of the control panel.

4. While the interior light is on and the “2n” is still displayed in the LED display, you can press the  button to scroll through the different colors within the Color Light Therapy System. You will notice that you have two selections for “white”:


- A. The first selection for “white” will allow the colors to go through a sequence of the different shades of colors.
- B. The second selection for “white” will continue to display the white light.




5. To return back to the Timer mode, press the  button.

e. You can operate the sauna with the ceiling vent in the open or closed position.

f. After your sauna session is over, you can turn the control panel off by pressing the ON/OFF button. You can unplug the sauna cord or switch the heavy duty surge protector to the OFF position.

g. To set the time, press the  buttons. Press  and  buttons to set the timer from 5 to 60 minutes. If pressed for three seconds, the timer will increase/decrease quickly. When the timer display shows “05”, the timer will buzz and the sauna will shut off automatically after 5 minutes. To extend the sauna

session, reset the timer again by pressing the .

h. The **Fahrenheit and Centigrade display** can be switched by pressing and holding the temperature button  and  at the same time and then pressing the .

i. **CD Player (optional)**

Please read the instruction provided with the CD player.

**CAUTION: Exit sauna immediately if you feel dizzy, sleepy, or any discomfort.**

## Warnings

### 1. Safety precautions

- a. To avoid fire, do not dry clothes or leave any towels in the sauna room. Do not cover the floor heater with any towels.
- b. Do not install the sauna near water, near a bathtub, near a shower, in a wet basement, or near a swimming pool.
- c. To prevent burns or electric shocks, do not touch or use metal tools on the protective material covers of the heat emitter panels.
- d. When replacement parts are required, be sure they meet the specified requirements of the manufacturer. Unauthorized substitutes may result in fire, electric shock, or other hazardous conditions. After any repairs, please perform safety checks to determine that your sauna is working properly.
- e. While in the sauna, do not touch the light bulb. If the bulb needs to be changed, switch it off and wait until the sauna is shut off and the bulb is cool.
- f. Do not use any wall receptacle adapter or extension cord between the sauna cord and wall receptacle. An applicable heavy duty surge protector can be used.
- g. Do not spray water on the heat emitter panels. This may result in electric shock or damage to the heat emitters.
- h. Always consult your physician for medical advice before using the sauna room.
- i. Do not use the sauna if you have any of the following conditions below:
  1. Open wounds
  2. Eye diseases
  3. Severe sunburns
  4. The elderly & weak. Those suffering from any medical condition or disease. Pregnant women and children should not use the sauna room. Children should not use the sauna unless prescribed by a medical physician and under the supervision of an adult.
  5. If suffering from a disease directly related to temperature, seek the advice of a medical physician before using the sauna.
  6. Do not place pets in the sauna.
  7. Never use the sauna if you are taking medications or consuming alcohol.

## Troubleshooting:

|   | problem                                      | possible reason                            | countermeasure   |
|---|--|--|--|
| 1 | indicator light for power supply not working | The connector is not connected properly    | Check the connector or replace a new one                       |
|   |  | No power supply input                      | Check your circuit breaker to confirm power at the wall outlet |
|   |  | Indicator light is broken                  | replace the circuit panel                                      |
| 2 | Indicator light for function is not working  | The heating indicator light is broken      | Replace the relevant control panel                             |
|   |  | The circuit board or components are broken | Replace the circuit board                                      |
|   |  | The temperature sensor is broken           | check the connection of the temperature sensor                 |



|    |                                    |   |  |
|----|------------------------------------|---|--|
| 3  | Infrared Heater not heating up     | The heater is broken  | Replace heater panel   |
|    |                                    | The wire junction or the heater's wire is not connected                           | Check that the connections are snug and tight  |
|    |                                    | The temperature sensor is broken  | check the connection of the temperature sensor   |
|    |                                    | The circuit board or the relay is not working                                     | replace the circuit board  |
| 4  | Odor from the sauna                | Power supply problem  | Power supply may need to be replaced   |
| 5  | Light bulb is not working          | Light bulb is burned out  | Remove burned out light bulb and replace it  |
|    |                                    | Light bulb wiring is loosen   | Check connection and/or replace the lamp assembly  |
|    |                                    | Problems with electrical control panel  | Replace the relevant control panel   |
| 6  | Sauna is not powering up           | Power cord is unplug  | Plug the power cord into wall outlet   |
|    |                                    | Outlet has no power   | Check your circuit breaker to confirm power at the wall outlet                                     |
|    |                                    | Power supply or circuit panel is broken   | Replace the power supply or related circuit board  |
| 7  | The temperature display shows "EP" | The connector of temperature sensor is loose, not connected, or sensor is damaged | Disconnect and reconnect the connector of temperature sensor or change to a new temperature sensor |
| 8  | The temperature display shows "H"  | The temperature inside the sauna room is too high                                 | Turn off the unit, and contact the manufacturer  |
| 9  | Speaker does not work              | The speaker is broken   | Replace with a new one of the same specifications  |
|    |                                    | The speaker wire is loose   | Disconnect and reconnect the speaker connections   |
|    |                                    | The power indicator light for CD is off   | Turn on the switch to start work   |
| 10 | CD-Player doesn't work             | Power connector is loose or damage  | Disconnect and reconnect the connection  |
|    |                                    | DC power supply has no power to the CD-player                                     | Check DC power supply wiring or replace the power supply   |
|    |                                    | CD-player is defective  | Replace the CD-player  |
|    |                                    | CD-player protection fuses is burnt out   | Replace the fuses  |

## Maintenance:

### Cleaning

Do not use liquid cleaners or aerosol cleansers inside the sauna. Unplug the sauna from the wall outlet before cleaning.

Use plain water and a soft cloth for cleaning. **Do not use benzene, alcohol, or strong cleaning chemicals in or on the sauna. NOTE: Any chemical that can damage wood or be absorbed into the wood will damage the sauna.**

## Transportation and storage

1. Avoid exposure to rain, snow or other strong weather elements.
2. Do not store in damp environments.

## Packing list

|                                |                         |                        |
|--------------------------------|-------------------------|------------------------|
| 1pc Front Board                | 1pc Back Board          | 2pcs Side panels       |
| 1pc Bottom Panel               | 1pc Ceiling             | 1pc Ceiling Cover      |
| 1pc Bench                      | 1pc Bench Heating Board | 1pc Light              |
| 1pc CD Player and 2pc Speakers | 1pc CD Player Box       | 1pc Instruction manual |
| 1pc Handle set                 |                         |                        |



## Limited Lifetime Warranty

**\*Limited Lifetime Warranty:** Golden Designs, Inc. warrants the heating elements and electronics against defects in material and workmanship for the life of the product from the original date of purchase. **This sauna is for INDOOR use only. Placing your sauna outdoors will VOID this warranty. Any damage due to exposure to outdoor elements such as rain, snow, sun, wind or extreme temperatures will not be covered by this warranty. Any damages as a result of modifications made to the sauna or its components will void this warranty.**

---

### Extent of Warranty

This limited warranty applies to products manufactured or distributed by Golden Designs, Inc. under the Dynamic brand name, delivered in the continental United States or Canada and extends to the original purchaser at the original site of installation only. This warranty becomes valid at time of purchase and terminates either by specified time frame listed above, owner transfer, or relocation. **Your sales receipt showing the date of purchase of the product is your proof of purchase.**

### Manufacturer Warranty

All Golden Designs, Inc. products are manufactured with the highest quality appliances and are warranted to be free from defects in material and workmanship at the time of delivery. The appliance warranty is extended through the manufacturer for the product including, but not limited to: stereos, CD/DVD players, etc. All exchanged parts and products replaced under this warranty will become the property of Golden Designs, Inc. Golden Designs, Inc. reserves the right to change manufactures of any part to cover any existing warranty. Any parts determined to be defective must be returned to Golden Designs, Inc. to obtain warranty service. You must prepay any shipping charges, export taxes, custom duties and taxes, or any other charges associated with the transportation of the parts. In addition you are responsible for insuring any parts shipped or returned. You must present Golden Designs, Inc. with proof of purchase documents (including the date of purchase). Any evidence of alteration, erasing or forgery of proof of purchase documents will be cause to **VOID** this limited warranty. Products on which the serial number has been defaced or removed is not eligible for warranty service.

### Warranty Limitations

This warranty does not apply if the unit has been subject to negligence, alteration, modification, misuse, abuse, repairs by non-Golden Designs, Inc. authorized personnel, inappropriate installations, or any case beyond the control of Golden Designs, Inc. invalidating this warranty including but are not limited to:

- Use of lacquer or paints
- Sauna and other Golden Designs, Inc. products accessories placed on non-approved surfaces
- Outdoor applications
- Normal wear and tear or weathering
- Use of product not in accordance with instructions

**Surface cracks are not considered defects in material or workmanship, as they are normal characteristics of all woods. This includes minor cracks due to wood expansion and contraction. Note: Since the wood used in construction has been kiln dried, a certain amount of expansion and contraction occurs in the wood in a sauna environment.**

### Disclaimers

Golden Designs, Inc. shall not be liable for loss of use of sauna or other Golden Designs, Inc. products or other secondary or incidental or

consequential costs, expense or damages - which may include the removal of permanent deck or other custom fixtures or the necessity for crane removal - arising directly or indirectly out of the use or inability to use the product. Any implied warranty shall have duration equal of the applicable warranty stated above. Under no circumstances shall Golden Designs, Inc. or any of its representatives be held liable for injury to any person or damage to any property, however arising. Specifications are subject to change without notice or obligation.

**Legal Remedies**

This limited warranty gives you specific legal rights. You may have other rights, which may vary from state to state.

**Customer Service**

For customer service, contact your authorized dealer. If you need additional information or assistance, please email Golden Designs, Inc. At [info@goldendesignsinc.com](mailto:info@goldendesignsinc.com) or call (909) 212-5555.

\*Limited Lifetime Warranty of Sauna Products is 5 years on heating elements and electronics from the date of purchase. The radio and wood structure have a 1 year limited warranty.

**WARRANTY CARD**

Congratulations on your purchase of an Infrared Sauna from Golden Designs, Inc. Please take the time to complete the following Warranty Card and mail it back to:

**Golden Designs, Inc.  
3550 Jurupa Street, Unit B  
Ontario, CA 91761**

Please include a copy of your sales receipt showing date of purchase as this will serve as proof of purchase.

**Warranty will be VOID if the following warranty card is not mailed back within 60 days of purchase date along with proof of purchase.**

**\*\*Serial number (S/N) is located on the sauna’s front panel, rear panel, or on the carton.\*\***

DETACH HERE



**WARRANTY CARD**

All fields must be completed to validate the warranty.

Name: \_\_\_\_\_

Address: \_\_\_\_\_

City: \_\_\_\_\_ State: \_\_\_\_\_ Zip Code: \_\_\_\_\_

Phone Number: \_\_\_\_\_

Purchase Date: \_\_\_\_\_

Product Name: \_\_\_\_\_

Purchase From: \_\_\_\_\_

Serial Number: \_\_\_\_\_